

Section 7

75100-xx

C-Type Base Gun



75100 Print List

<u>Print</u>	<u>Page</u>
1. C-Type Base Gun Assembly-Cover.....	7-3
2. C-Type Base Gun Assembly.....	7-4
3. Moveable Arm Assembly.....	7-5
4. 35043 Pin Assembly.....	7-6
5. Mounting Bracket Assembly.....	7-7
6. Stationary Equalizer Assembly.....	7-8
7. 88016 Equalizer Assembly Sht-1.....	7-9
8. 88016 Equalizer Assembly Sht-2.....	7-10
9. 99016 Rod Boot Assembly.....	7-11



GROSSEL TOOL COMPANY

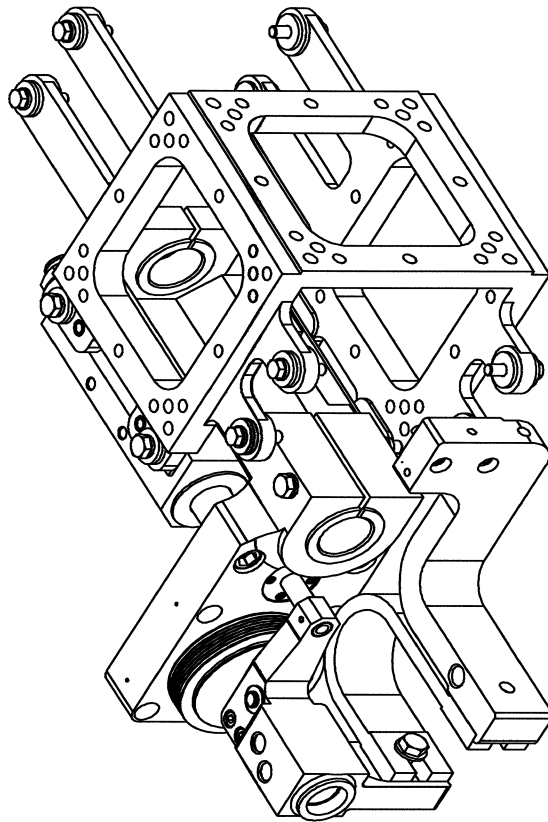

GROSSEL TOOL CO.
C-TYPE / ROBOT STYLE
BASE GUN ASSEMBLY
"75100-11" & "75100-15"

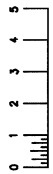

Grossel Tool
 Modular Base Gun Assembly MANUAL

SECTION 7: 75100-XX

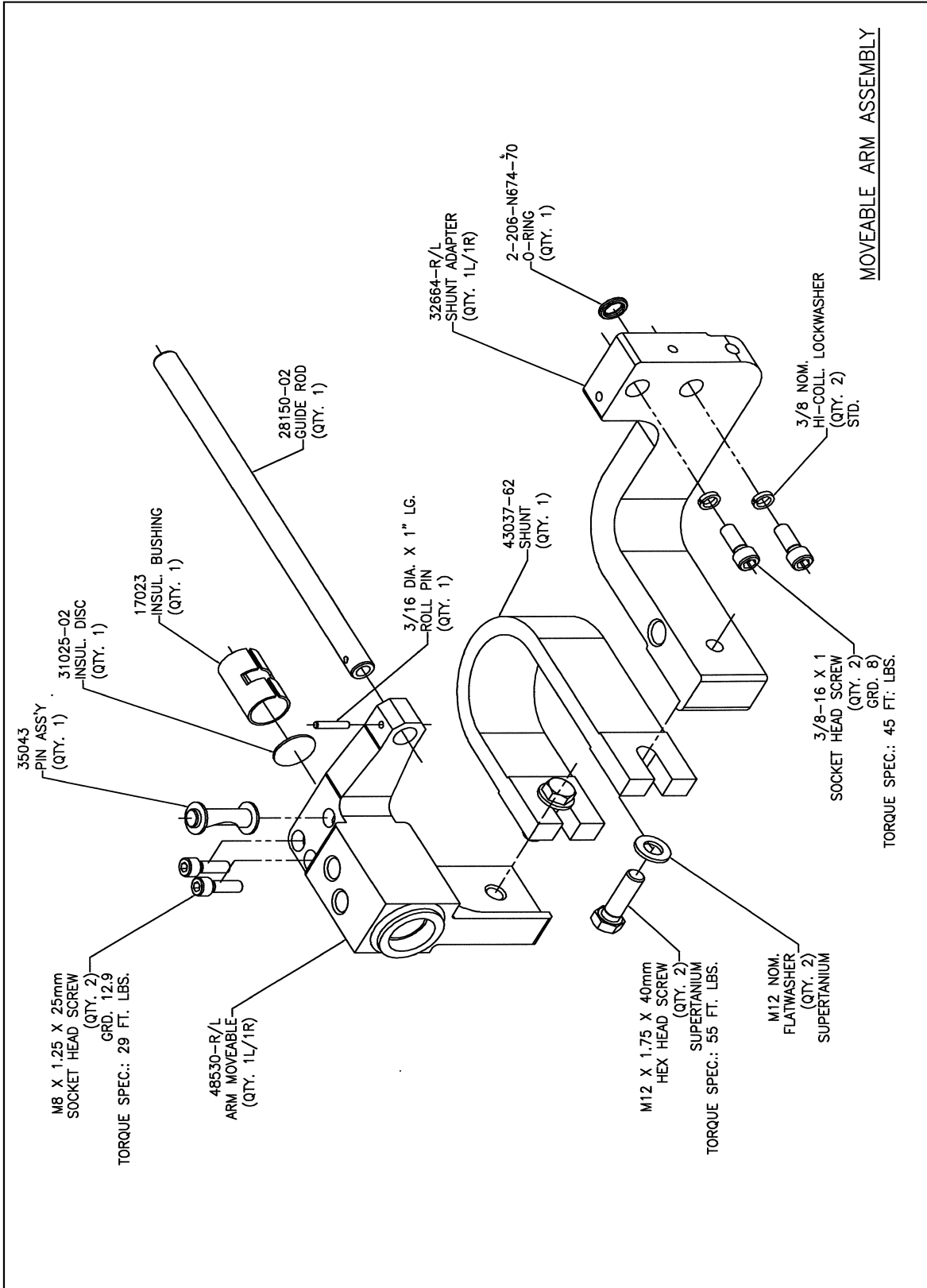

GROSSEF TOOL COMPANY

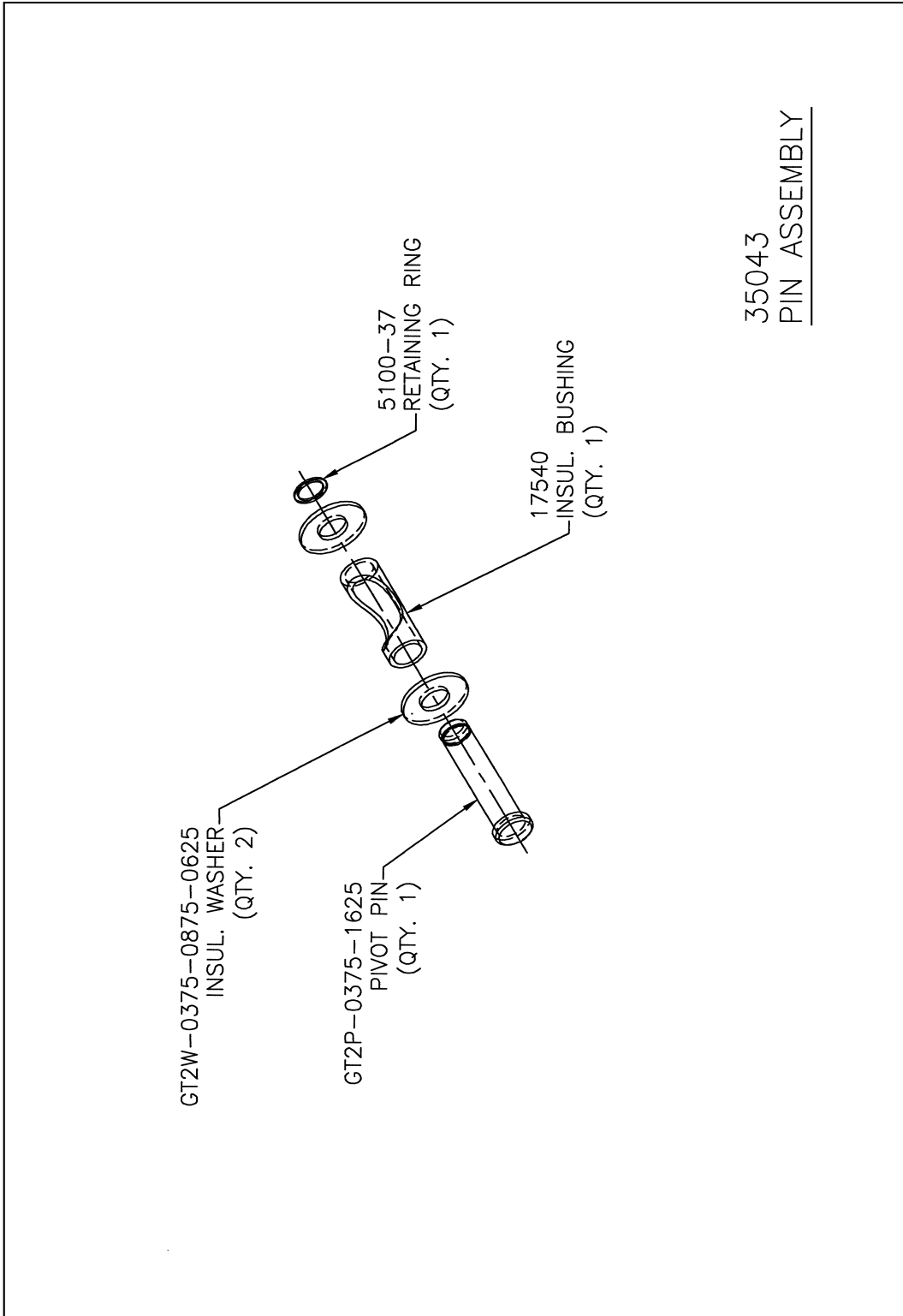

Grossel Tool Modular Base Gun Assembly MANUAL

SECTION 7: 75100-XX

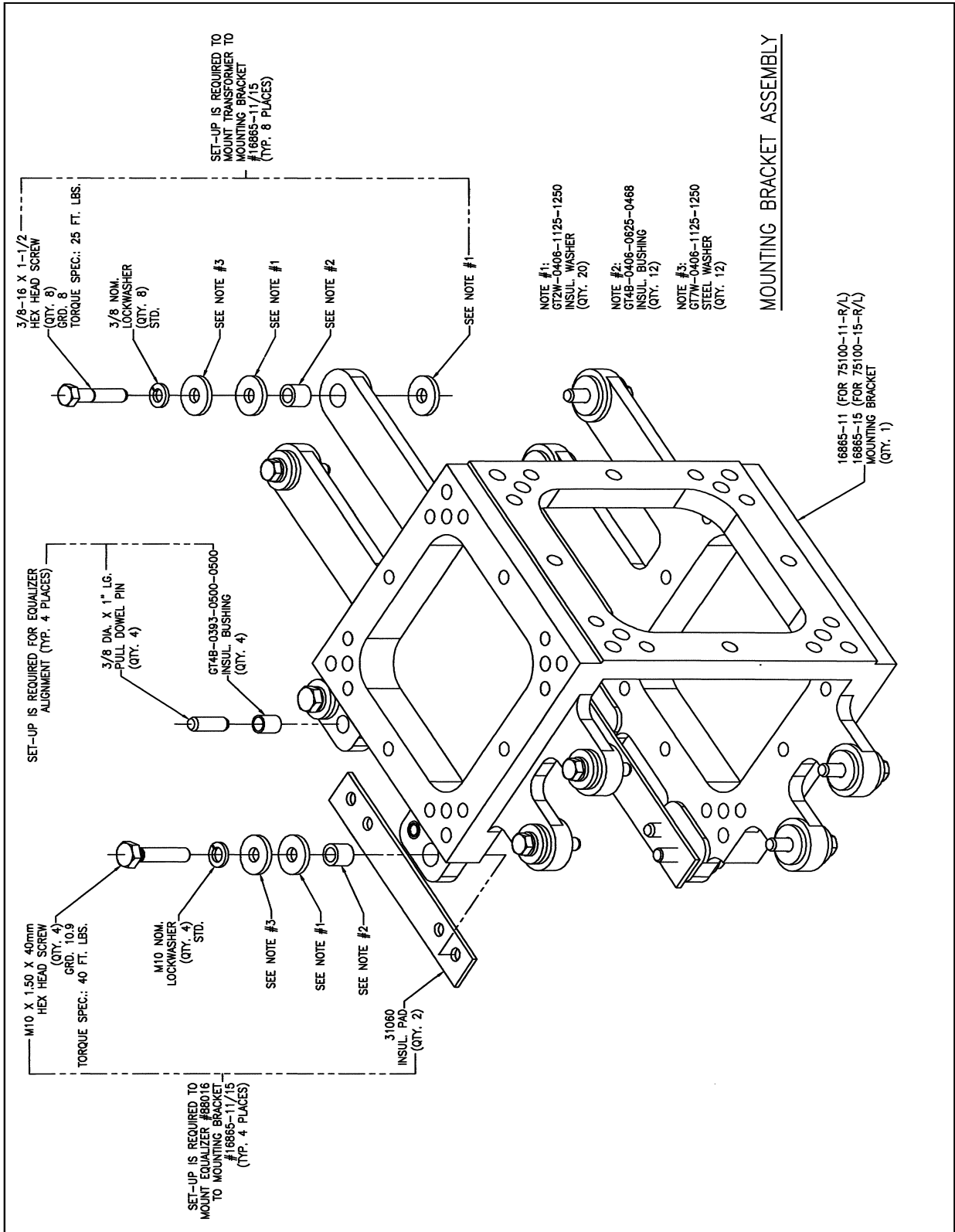

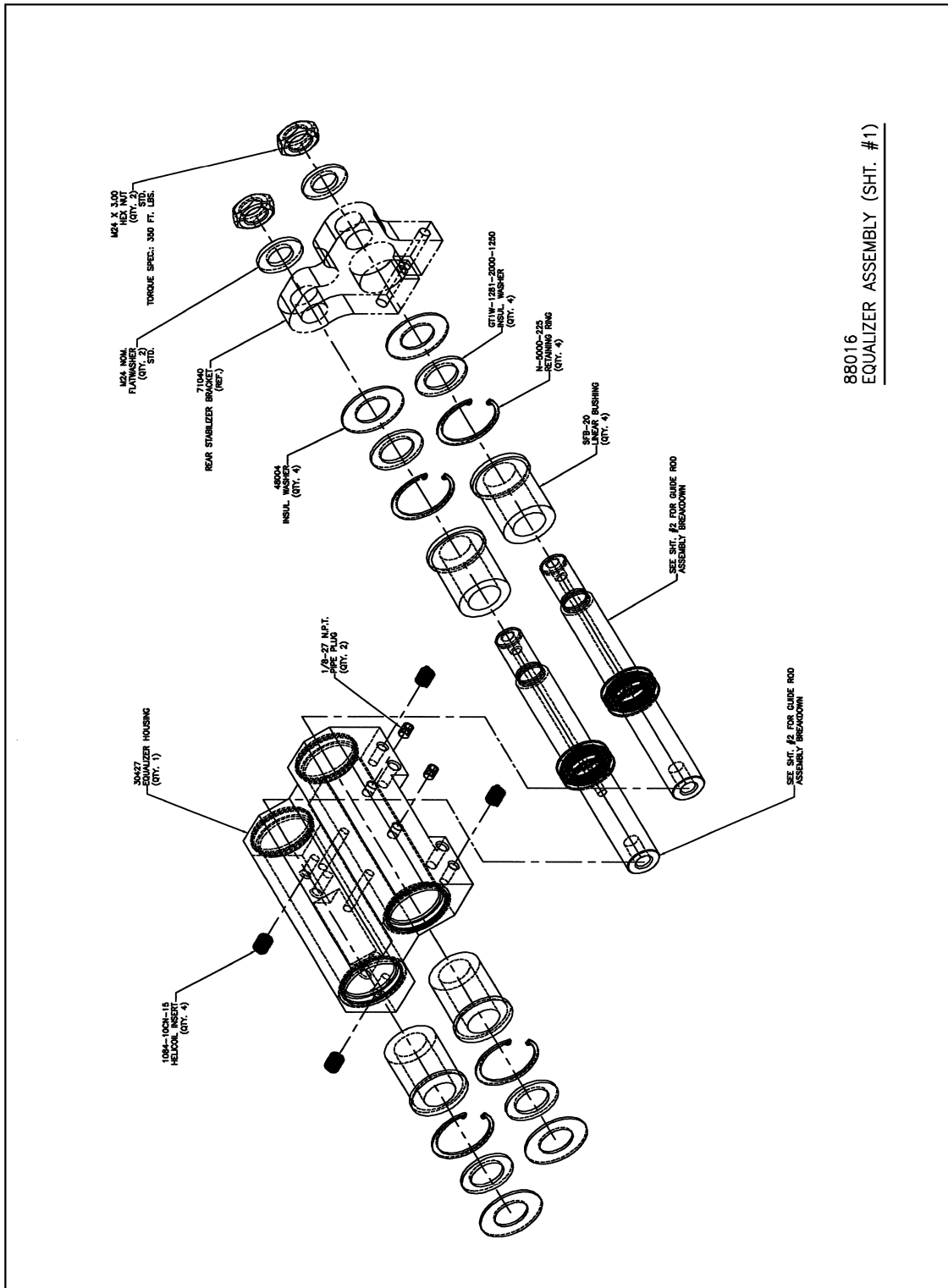

88016
 EQUALIZER ASSEMBLY (SHT. #1)

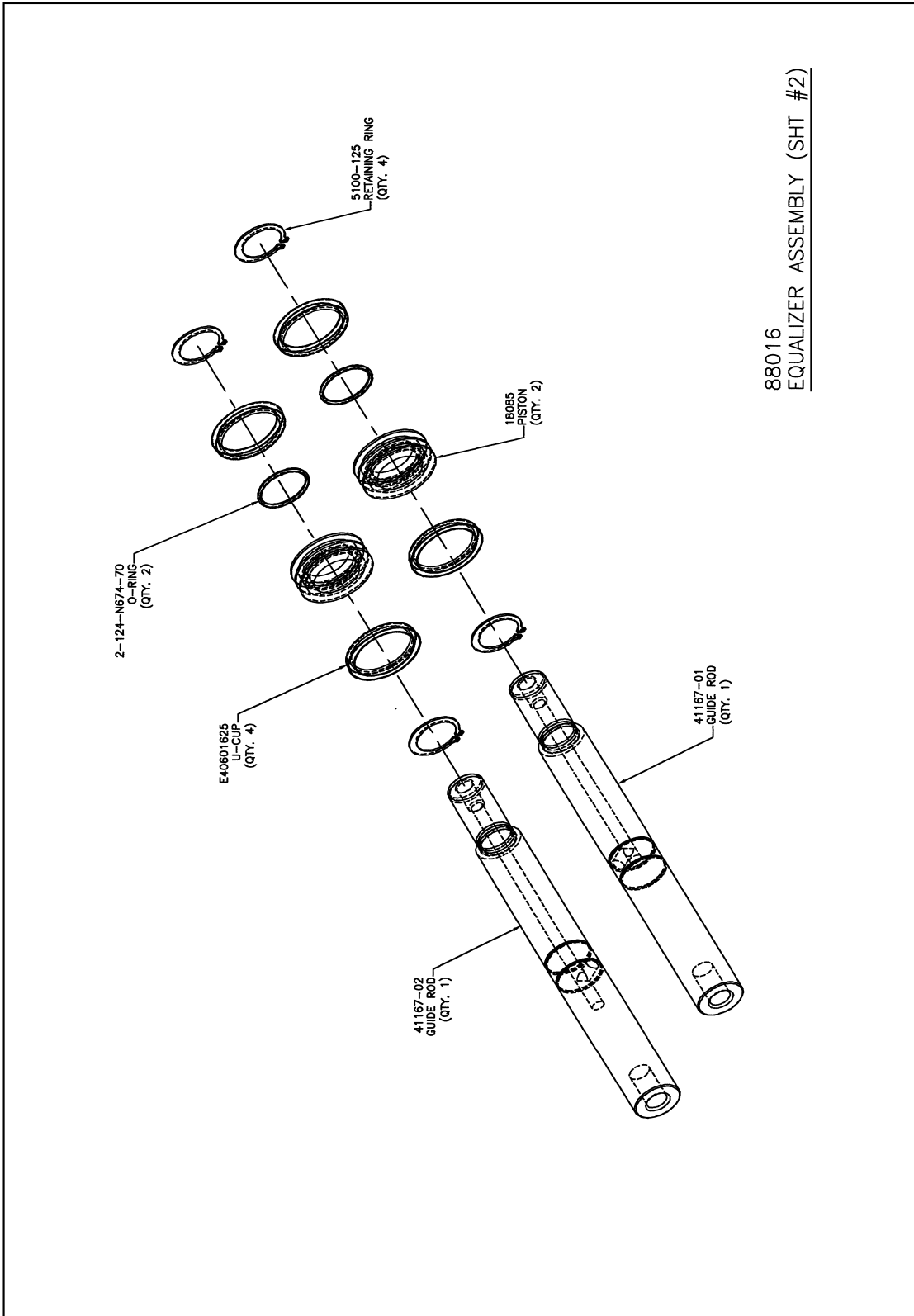

GROSSEL TOOL COMPANY

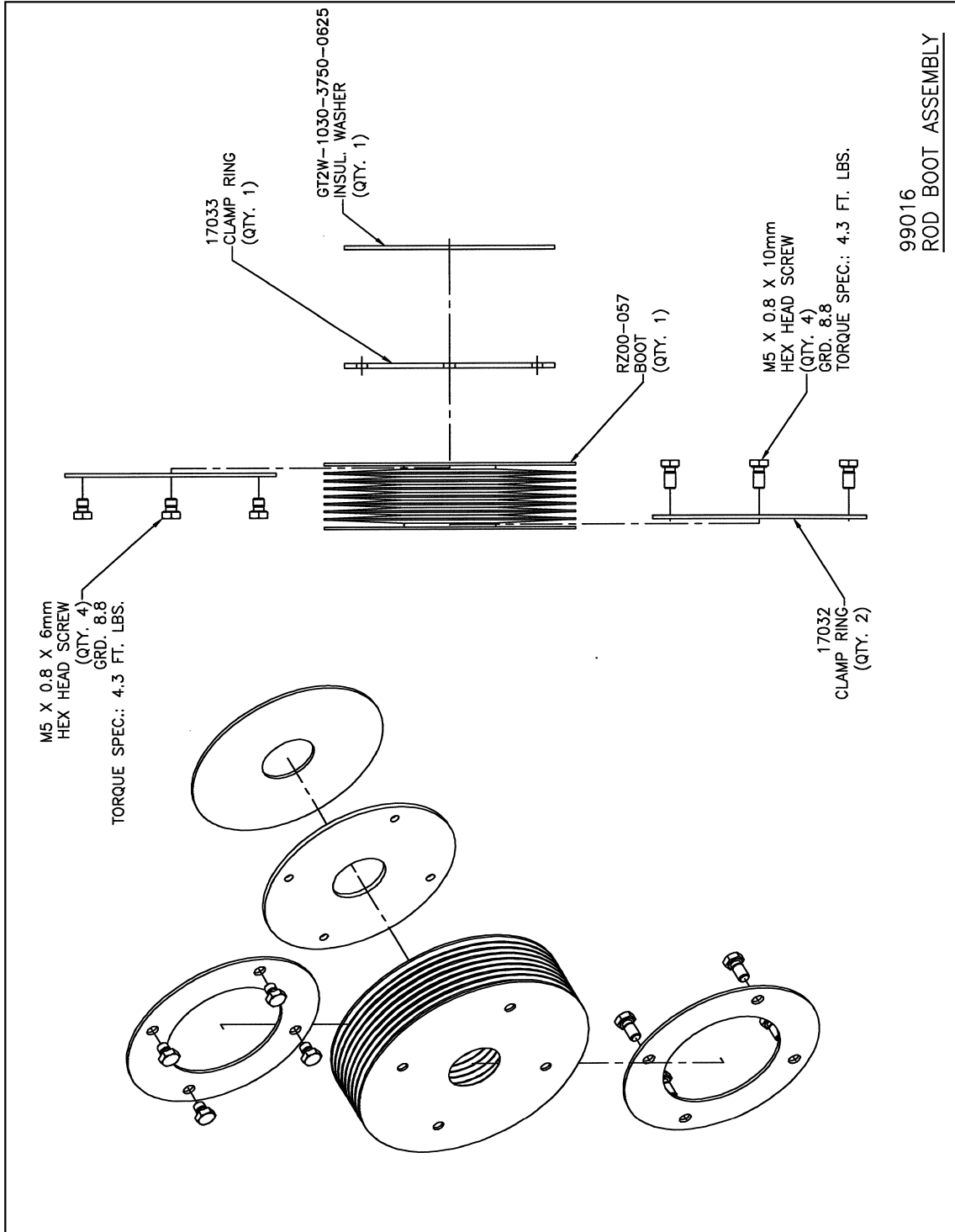

99016
 ROD BOOT ASSEMBLY

